

# Product Summary

# CS-15

**Mounting:** Pit

**Available Height (not including pit):** 3400mm

**Type:** Single Width

**Deck Finish:** Galvanised Pressed Metal

**Description:** Provides independent parking spaces for 2 cars, one on top of the other. Operated by means of a stand mounted switch, with usage instructions attached.

**Suitable for:** Standard passenger cars and station wagons. Please note that some vehicle shapes may be restricted.

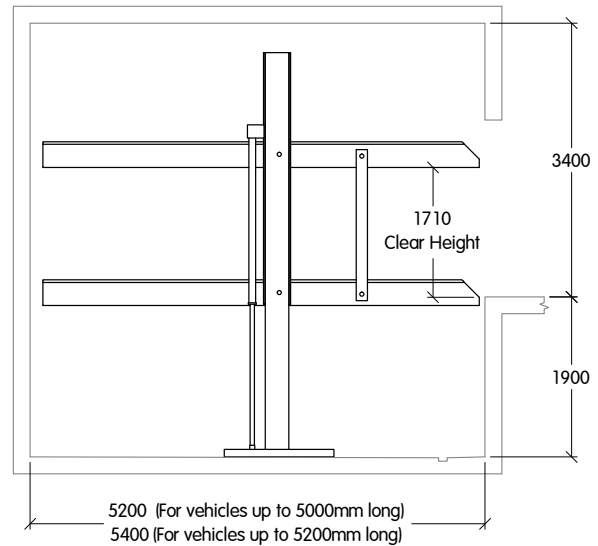

© Copyright Spacepark Global Pty Ltd. Please note that by using this drawing in any format, you accept that Spacepark owns the copyright. You are licensed to use this drawing for any Spacepark car parking system on which Spacepark are tendering, and you shall not knowingly allow others to copy this drawing. Obtain appropriate licences from Spacepark if you (or anyone employed or engaged by you) intend to use the intellectual property rights of Spacepark in performing your obligations under any contract. Spacepark reserves the right to amend specifications without notice for product improvement.



AUSTRALIA | CANADA | EUROPE | NEW ZEALAND | UNITED KINGDOM | USA

TOLL FREE: 1800 689 890 P: 1300 640 070 F: 1300 640 072 W: spacepark.com PO Box 6005, Baulkham Hills BC, NSW 2153, Australia  
SPACEPARK GLOBAL PTY LTD. ABN. 38 089 309 181

SPA016\_P5